











SMARTair™ Cabinet locks

Wireless and battery powered

Technical data – SMARTair™ Cabinet locks

	Application	Ideal for lockers and cabinets
	Verticals	All industries (e.g. healthcare with medical cabinets, gyms)
	Traffic volume	Standard
	Exterior usage	Yes (IP55), Up to 85% humidity without condensation, Temperature (-20°C and +70°C)
	Hardware compatibility and installation	High retrofit, Drilling, no cabling
	Power supply	Battery (up to 20.000 Cycles and max. 3 years), 3 x Standard LR03 AAA 1.5V batteries
	System management	Stand-Alone, Offline, Update on Card, Wireless online
	Multi-authentication	No
	Status information	No
	Certifications	CE

SMARTair™ Cabinet lock



1. RFID reader with LED (green/red signal) with 1cm read/write distance
2. Special water resistant bracelet for Health Spa's and swimming pools which enables users to go running or to swim available

Technical drawings and dimensions

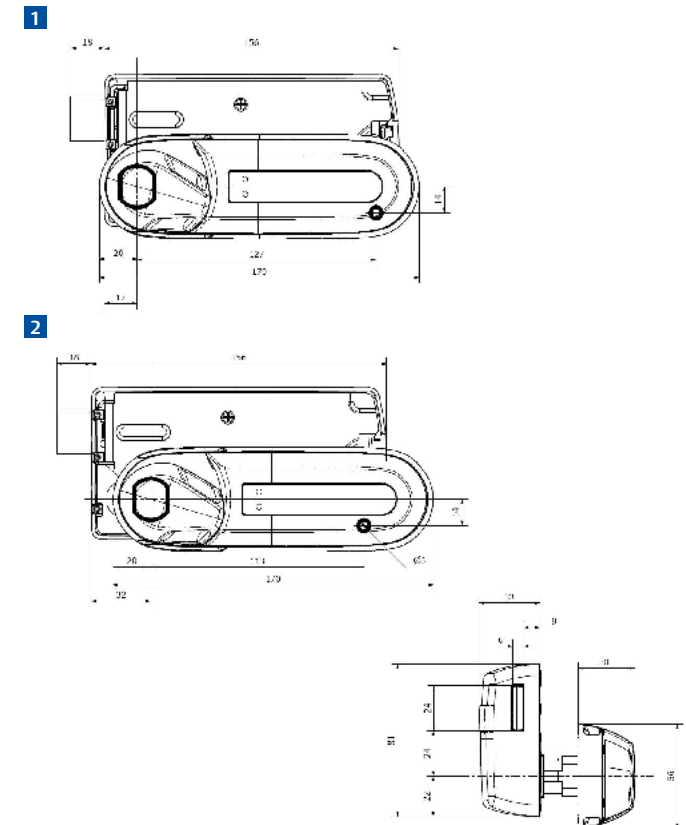

1. Right handed door short
2. Right handed door long